

KLEIN

Wooden-Metal Door

SLID PAIRED

Wooden-Metal Sliding Door
Puerta Corredera de Madera-Metal



SLID PAIRED



ENG

SLID PAIRED is an interior folding door system designed to fit in recessed openings through two folding panels, with no floor track. It allows maximum integration into the silhouette of false ceilings.

- New invisible hinges, integrated in the accessory set to have all installation elements.
- Two types of folding: central and side, to meet any architectural challenge.
- Recessed track (Top) for invisible installations.
- Optimum functionality through pivot system.
- Retrac system facilitates the installation of the set.
- Anodized silver aluminum surface.
- 2 panels, maximum of 165 lbs each.
- Panel thickness from 1 3/8".
- Compatible with standard invisible hinges..
- 5 year warranty.

Systems tested up to 100.000 cycles as per standard EN1527.

ESP

SLID PAIRED es un sistema para puertas plegables interiores diseñado para dos paneles plegables, libres de perfiles en el suelo. Ofrece una máxima integración del perfil en el falso techo en su versión empotrada.

- Nuevas bisagras invisibles, integradas en el juego de accesorios para disponer de todos los elementos de la instalación.
- Dos tipos de plegado: central y lateral, para cumplir con cualquier reto arquitectónico.
- Perfil Top empotrable para instalaciones invisibles.
- Funcionamiento óptimo gracias al sistema de pivotación.
- Sistema Retrac: facilita el montaje del conjunto.
- Perfil de aluminio anodizado Silver.
- Dos paneles, de hasta 165 lbs cada uno.
- Espesor de paneles a partir de 1 3/8".
- Compatible con bisagras invisibles estándares.
- 5 años de garantía.

Sistemas testados hasta 100.000 ciclos según la norma EN1527.

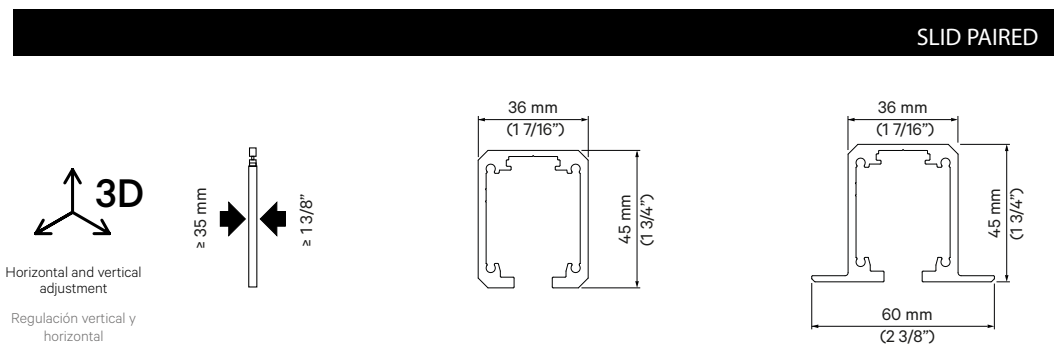

SIDE FOLDING / PLEGADO LATERAL



CENTRAL FOLDING / PLEGADO CENTRAL

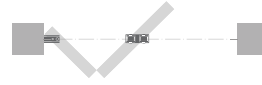

EXPOSED INSTALLATION /
INSTALACIÓN VISTA

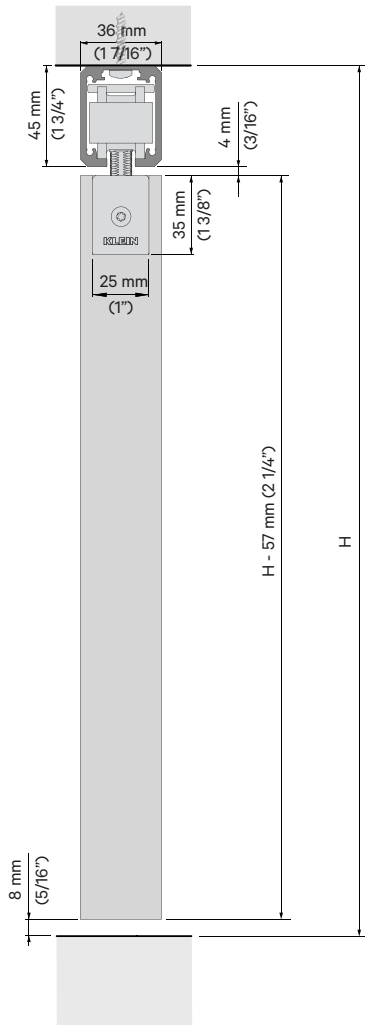

RECESSED INSTALLATION /
INSTALACIÓN EMPOTRADA

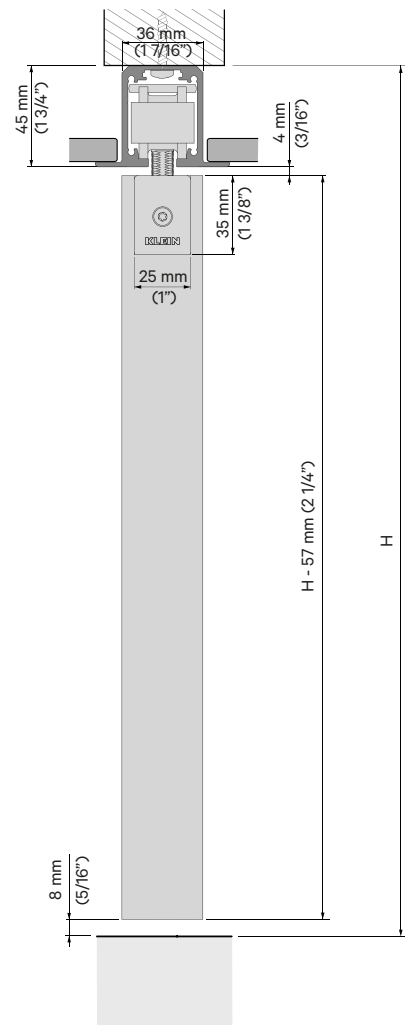

SLID PAIRED LATERAL

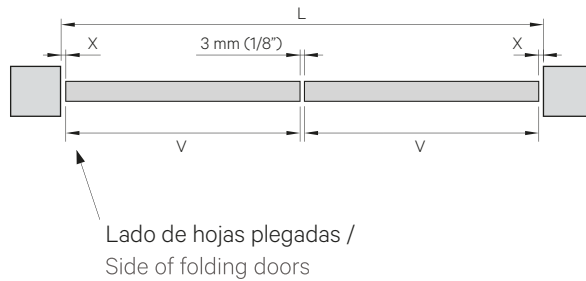
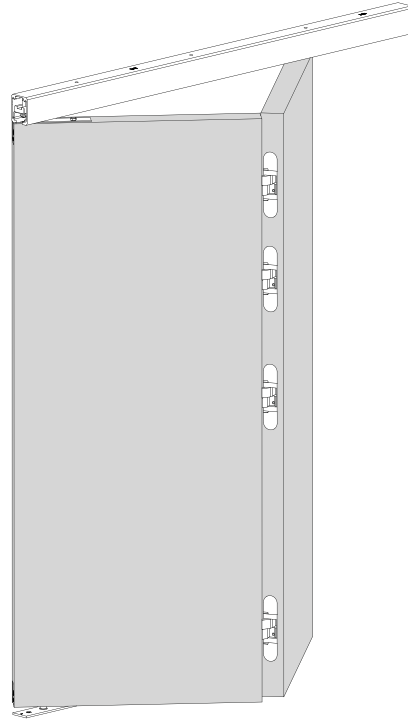

$$V = \frac{L - (2X) - 3 \text{ mm (1/8")}}{2}$$

V Min. = 350 mm (13 13/16")

V Max. = 1250 mm (49 3/16")

Esesor Puerta (Panel Thickness)	X
35 mm (1 3/8")	5 mm (3/16")
40 mm (1 9/16")	6 mm (1/4")
45 mm (1 3/4")	7 mm (9/32")
50 mm (2")	8 mm (5/16")

SLID PAIRED CENTRAL

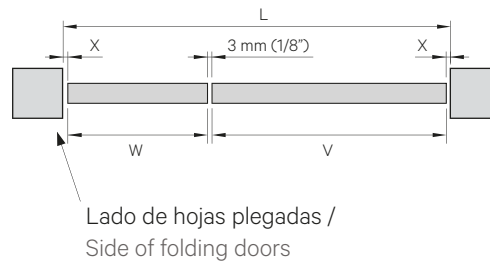
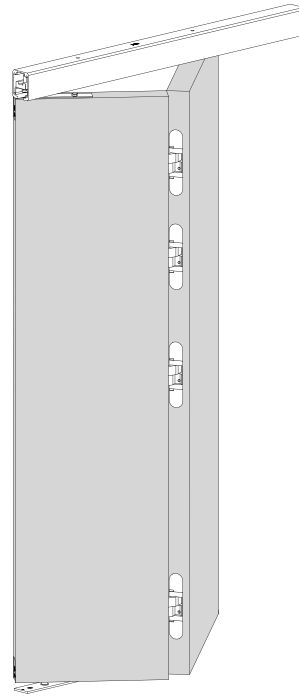

$$V = \frac{L - (47 \text{ mm} + 2X) - 3 \text{ mm}}{1,5}$$

$$W = \frac{V}{2} + 47 \text{ mm}$$

$$V = \frac{L - (1 \text{ 7/8}'' + 2X) - 1/8''}{1,5}$$

$$W = \frac{V}{2} + 1 \text{ 7/8}''$$

V Min. = 350 mm (13 13/16")

V Max. = 1250 mm (49 3/16")

Espeor Puerta (Panel Thickness)	X
35 mm (1 3/8")	5 mm (3/16")
40 mm (1 9/16")	6 mm (1/4")
45 mm (1 3/4")	7 mm (9/32")
50 mm (2")	8 mm (5/16")

N = Número de hojas (Number of panels)

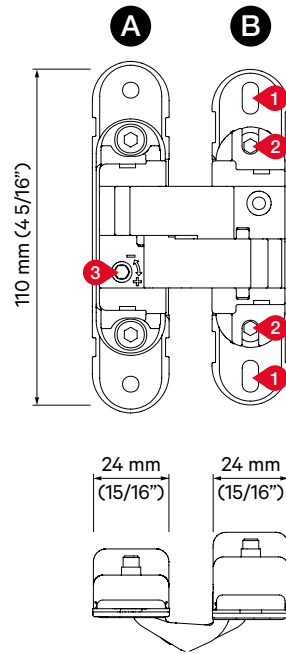

Regulación 3D

- 1 Vertical: $\pm 2,5 \text{ mm}$ (1/8")
- 2 Horizontal: $\pm 1,5 \text{ mm}$ (1/4")
- 3 Profundidad: $\pm 1 \text{ mm}$

PANEL FABRICATION / MECANIZACIÓN DEL PANEL

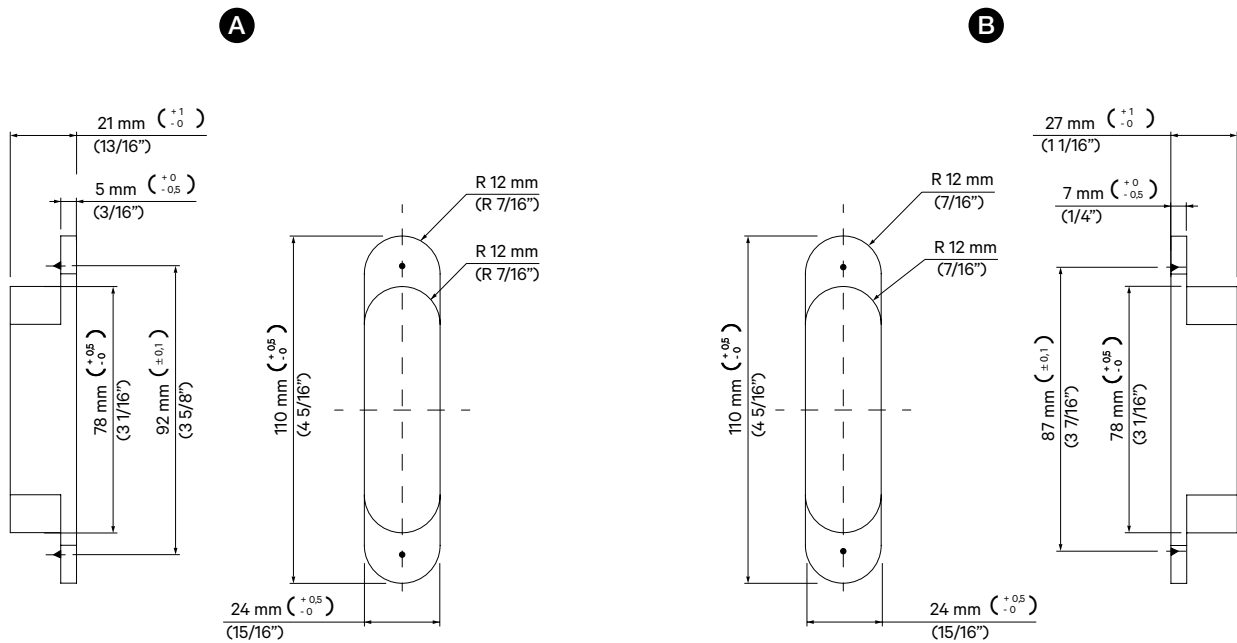

REFERENCES / REFERENCIAS

ENG

SLID PAIRED CENTRAL		
Ref.	Description	Img.
2759	KIT SLID PAIRED 150 CENTRAL SILVER (5' 10 13/16")	A
3085	KIT SLID PAIRED 150 CENTRAL SILVER (7' 10')	A

SLID PAIRED TOP CENTRAL		
Ref.	Description	Img.
2761	KIT SLID PAIRED 150 TOP CENTRAL SILVER (5' 10 13/16")	B
3086	KIT SLID PAIRED 150 TOP CENTRAL SILVER (7' 10")	B

SLID PAIRED LATERAL		
Ref.	Description	Img.
2741	KIT SLID PAIRED 150 LATERAL SILVER (5' 10 13/16")	C
2745	KIT SLID PAIRED 150 LATERAL SILVER (7' 10')	C
2698	KIT SLID PAIRED 150 LATERAL SILVER (9' 2")	C

SLID PAIRED TOP LATERAL		
Ref.	Description	Img.
2750	KIT SLID PAIRED 150 TOP LATERAL SILVER (5' 10 13/16")	D
2751	KIT SLID PAIRED 150 TOP LATERAL SILVER (7' 10")	D
2699	KIT SLID PAIRED 150 TOP LATERAL SILVER (9' 2")	D

SLID PAIRED DUO CENTRAL		
Ref.	Description	Img.
3087	KIT SLID PAIRED 150 DUO CENTRAL SILVER (5' 10 13/16")	E
3088	KIT SLID PAIRED 150 DUO CENTRAL SILVER (7' 10")	E
3089	KIT SLID PAIRED 150 DUO CENTRAL SILVER (9' 2")	E
3090	KIT SLID PAIRED 150 DUO CENTRAL SILVER (11' 1 13/16")	E
2760	KIT SLID PAIRED 150 DUO CENTRAL SILVER (13' 1")	E

SLID PAIRED TOP DUO CENTRAL		
Ref.	Description	Img.
3091	KIT SLID PAIRED 150 TOP DUO CENTRAL SILVER (5' 10 13/16")	F
3092	KIT SLID PAIRED 150 TOP DUO CENTRAL SILVER (7' 10")	F
3093	KIT SLID PAIRED 150 TOP DUO CENTRAL SILVER (9' 2")	F
3094	KIT SLID PAIRED 150 TOP DUO CENTRAL SILVER (11' 1 13/16")	F
2762	KIT SLID PAIRED 150 TOP DUO CENTRAL SILVER (13' 1")	F

SLID PAIRED DUO LATERAL		
Ref.	Description	Img.
2749	KIT SLID PAIRED 150 DUO LATERAL SILVER (13' 1")	G
2688	KIT SLID PAIRED 150 DUO LATERAL SILVER (19' 8")	G

SLID PAIRED DUO TOP LATERAL		
Ref.	Description	Img.
2755	KIT SLID PAIRED 150 TOP DUO LATERAL SILVER (13' 1")	H
2689	KIT SLID PAIRED 150 TOP DUO LATERAL SILVER (19' 8")	H

ESP

SLID PAIRED CENTRAL		
Ref.	Descripción	Img.
2759	KIT SLID PAIRED 150 CENTRAL SILVER (5' 10 13/16")	A
3085	KIT SLID PAIRED 150 CENTRAL SILVER (7' 10")	A

SLID PAIRED TOP CENTRAL		
Ref.	Descripción	Img.
2761	KIT SLID PAIRED 150 TOP CENTRAL SILVER (5' 10 13/16")	B
3086	KIT SLID PAIRED 150 TOP CENTRAL SILVER (7' 10")	B

SLID PAIRED LATERAL		
Ref.	Descripción	Img.
2741	KIT SLID PAIRED 150 LATERAL SILVER (5' 10 13/16")	C
2745	KIT SLID PAIRED 150 LATERAL SILVER (7' 10')	C
2698	KIT SLID PAIRED 150 LATERAL SILVER (9' 2")	C

SLID PAIRED TOP LATERAL		
Ref.	Descripción	Img.
2750	KIT SLID PAIRED 150 TOP LATERAL SILVER (1,8m)	D
2751	KIT SLID PAIRED 150 TOP LATERAL SILVER (2,4m)	D
2699	KIT SLID PAIRED 150 TOP LATERAL SILVER (9' 2")	D

SLID PAIRED DUO CENTRAL		
Ref.	Descripción	Img.
3087	KIT SLID PAIRED 150 DUO CENTRAL SILVER (5' 10 13/16")	E
3088	KIT SLID PAIRED 150 DUO CENTRAL SILVER (7' 10")	E
3089	KIT SLID PAIRED 150 DUO CENTRAL SILVER (9' 2")	E
3090	KIT SLID PAIRED 150 DUO CENTRAL SILVER (11' 1 13/16")	E
2760	KIT SLID PAIRED 150 DUO CENTRAL SILVER (13' 1")	E

SLID PAIRED TOP DUO CENTRAL		
Ref.	Descripción	Img.
3091	KIT SLID PAIRED 150 TOP DUO CENTRAL SILVER (5' 10 13/16")	F
3092	KIT SLID PAIRED 150 TOP DUO CENTRAL SILVER (7' 10")	F
3093	KIT SLID PAIRED 150 TOP DUO CENTRAL SILVER (9' 2")	F
3094	KIT SLID PAIRED 150 TOP DUO CENTRAL SILVER (11' 1 13/16")	F
2762	KIT SLID PAIRED 150 TOP DUO CENTRAL SILVER (13' 1")	F

SLID PAIRED DUO LATERAL		
Ref.	Descripción	Img.
2749	KIT SLID PAIRED 150 DUO LATERAL SILVER (13' 1")	G
2688	KIT SLID PAIRED 150 DUO LATERAL SILVER (19' 8")	G

SLID PAIRED DUO TOP LATERAL		
Ref.	Descripción	Img.
2755	KIT SLID PAIRED 150 TOP DUO LATERAL SILVER (13' 1")	H
2689	KIT SLID PAIRED 150 TOP DUO LATERAL SILVER (19' 8")	H



A

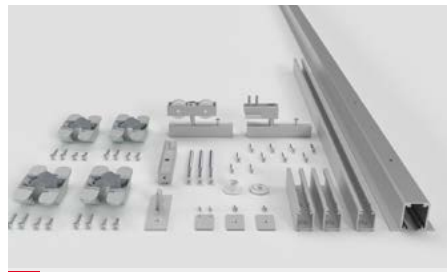

B



C

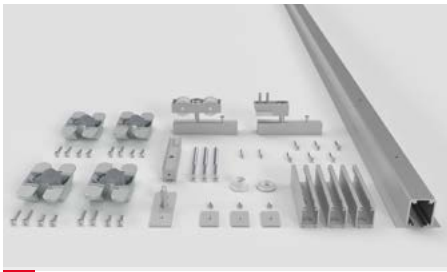

D

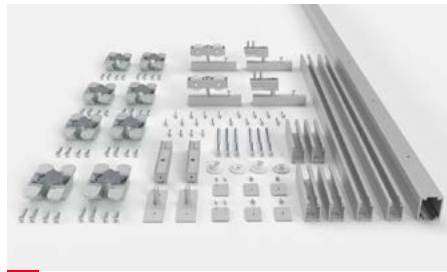

E

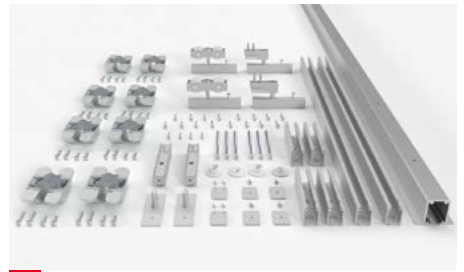

F

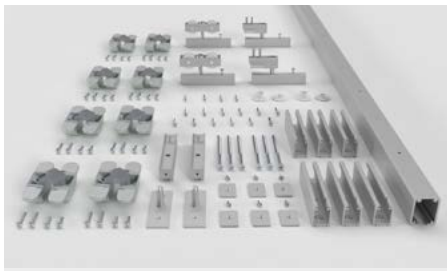

G



H

KLEIN

KLEIN USA, Inc.*
1 Madison Street
East Rutherford, NJ 07073

Phone: 973 246 8181
Fax: 973 246 8362
info@klein-usa.com
www.klein-usa.com

Follow us on social media
Siguenos en redes

