

ELEVATION - CLOSED POSITION  
[VIEW FROM INSIDE OFFICE]

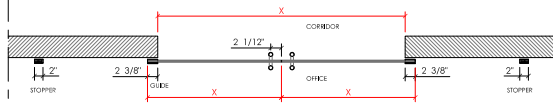

PLAN - CLOSED POSITION

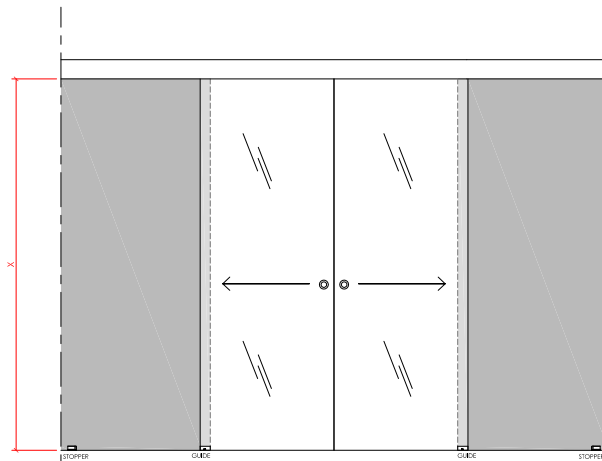

ELEVATION - CLOSED POSITION  
[VIEW FROM INSIDE OFFICE]

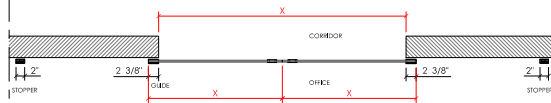

PLAN - CLOSED POSITION

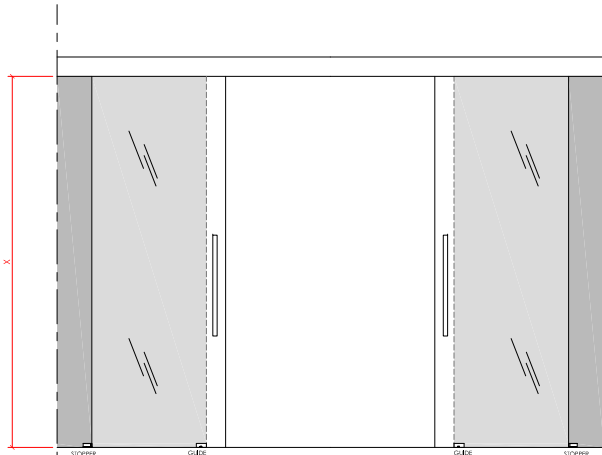
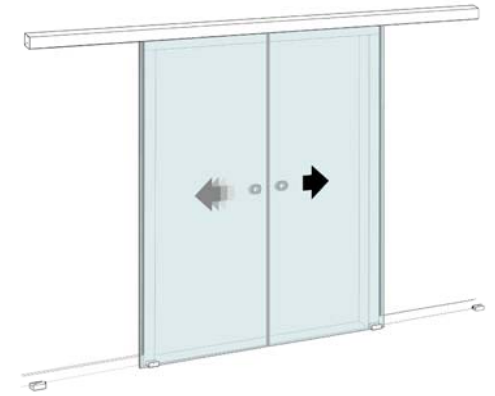

ELEVATION - OPENED POSITION  
[VIEW FROM INSIDE OFFICE]



PLAN - OPENED POSITION

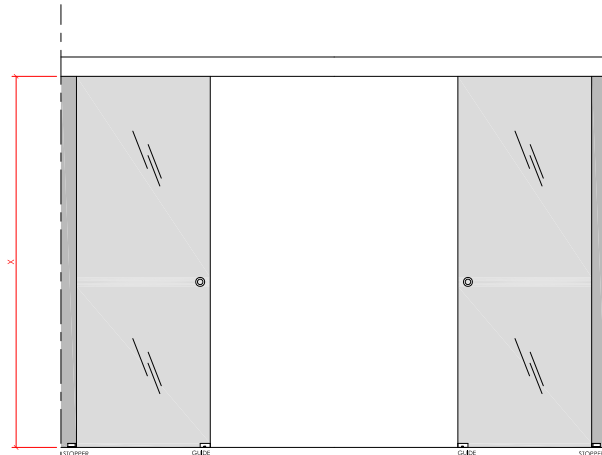

ELEVATION - OPENED POSITION  
[VIEW FROM INSIDE OFFICE]



PLAN - OPENED POSITION

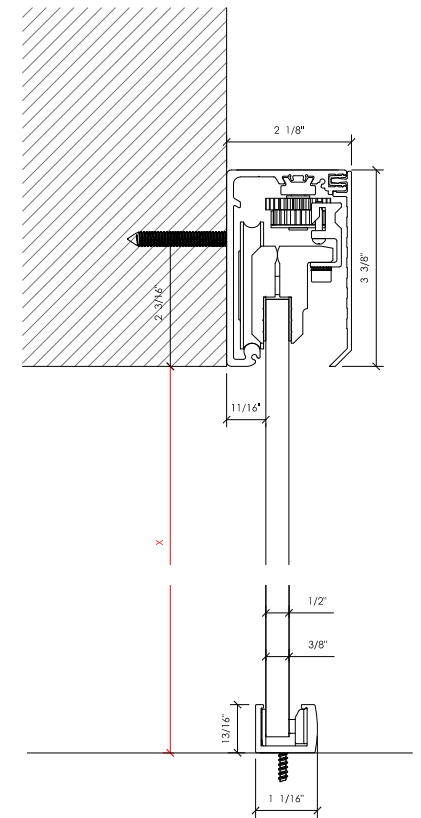

UNIKMATIC GLASS OFFICE FRONTS



TRACK AT WALL  
EXPOSED TRACK

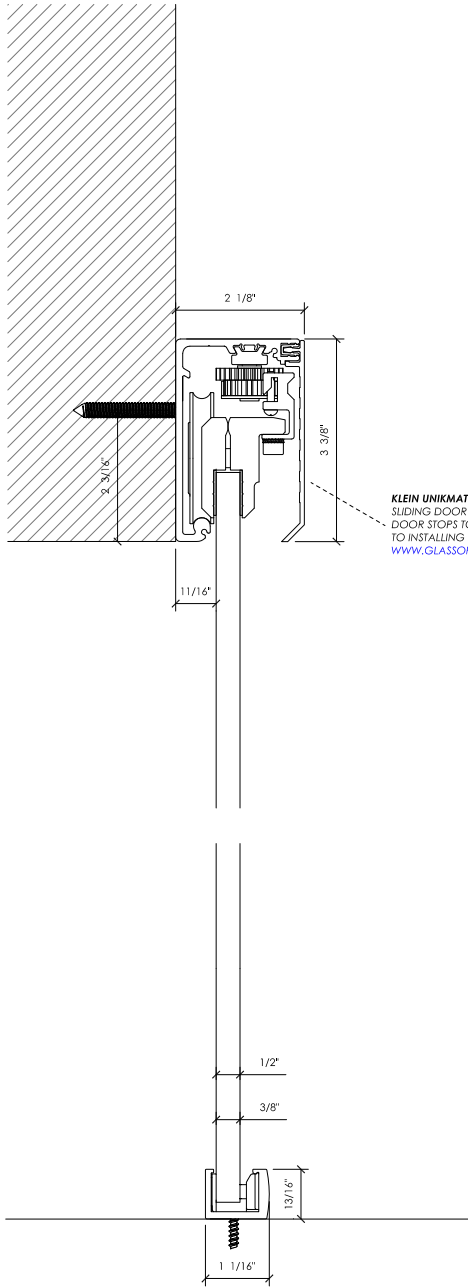

KLEIN UNIKMATIC  
SLIDING DOOR SYSTEM  
DOOR STOPS TO BE PLACED PRIOR  
TO INSTALLING THE TRACK  
[WWW.GLASSOFFICEFRONTS.COM](http://WWW.GLASSOFFICEFRONTS.COM)

KLEIN UNIKMATIC  
SLIDING DOOR SYSTEM  
DOOR STOPS TO BE PLACED PRIOR  
TO INSTALLING THE TRACK  
[WWW.GLASSOFFICEFRONTS.COM](http://WWW.GLASSOFFICEFRONTS.COM)

TRACK AT WALL  
RECESSED TRACK

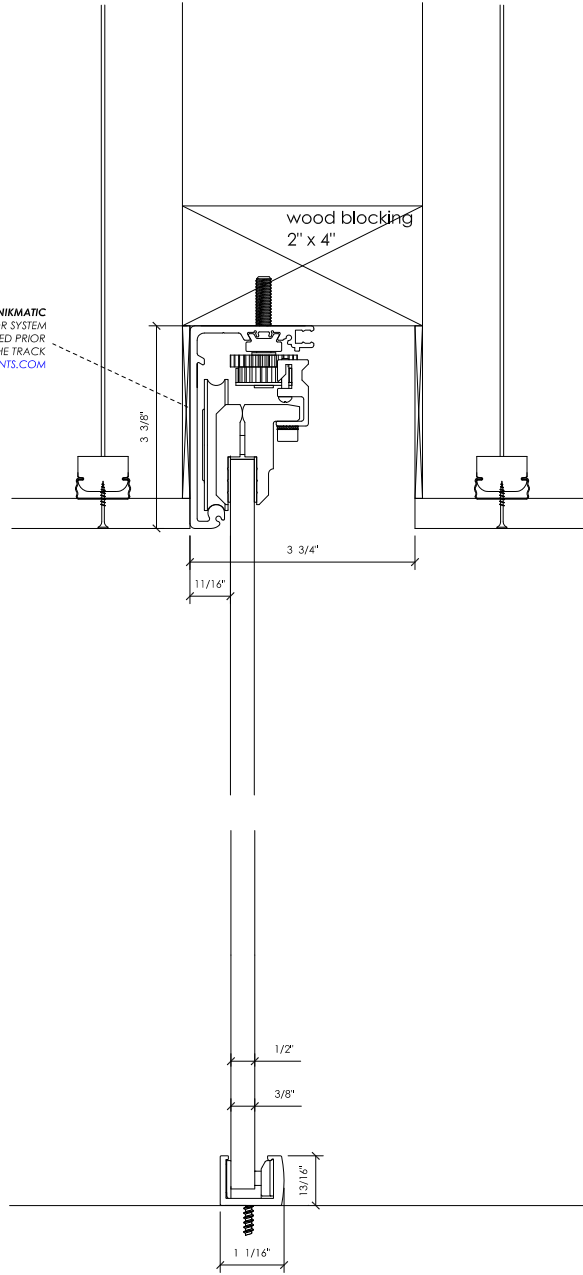

DOOR DETAILS WITH BAR HANDLE - CLOSED POSITION

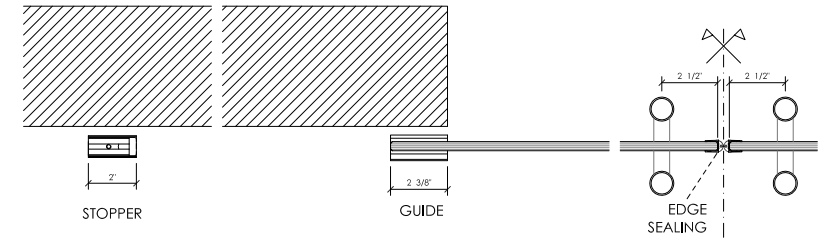

DOOR DETAILS WITH BAR HANDLE - OPENED POSITION

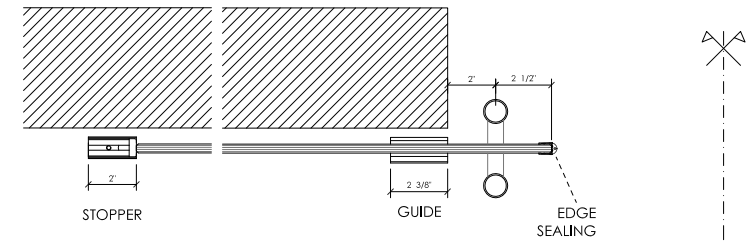

DOOR DETAILS WITH ROUND PULL - CLOSED POSITION

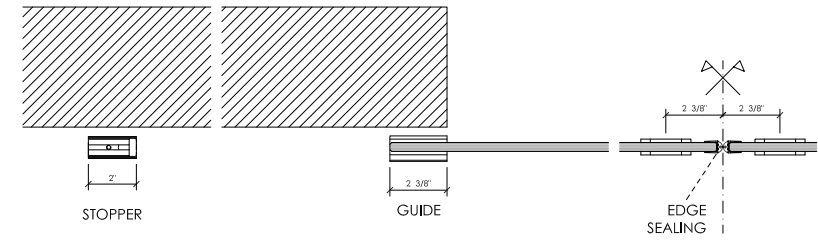

DOOR DETAILS WITH ROUND PULL - OPENED POSITION

